

MADE FOR YOU™ SILHOUETTES™

With Silhouettes Upholstery, the possibilities for personalized seating are limited only by your imagination. Mix and match to suit your style and specific needs, and our craftspeople will create one-of-a-kind upholstery with our renowned high-quality construction methods including solid hardwood frames, triple doweled joints, custom-engineered seating with eight-way hand-tied springs and four-way hand-tied tight backs. Silhouettes upholstery, which can be covered in our fabrics as well as your own COM yardage, also features four-way flow-matched tailoring and standard spring down cushions with goose feather throw pillows.

EASY AS 1,2,3

We've made it fast and easy to design your own Silhouettes Upholstery with helpful worksheets and guides. These worksheets may be submitted via an email form, downloaded from Homebase or photocopied from this Sourcebook. Please note that orders must be accompanied by a completed worksheet to ensure that every option has been selected exactly as you want.

Designing your own seating with Silhouettes Upholstery is easy if you follow these simple steps:

Pick your base:	Exposed Legs, Kick Pleat or Dressmaker Skirt
Pick your silhouette:	Sofa, Chair, Ottoman, Chaise, or Sectional
Pick your seat height:	19 $\frac{3}{4}$ " or 21 $\frac{3}{4}$ "
Pick your arm:	Choose from 10 different arm styles or Armless
Pick your back:	Knife Edge Back, Box Edge Back or Tight Back
Pick your leg:	Exposed Legs... 12 styles
Pick your depth and height:	Standard Depth or Extended Depth, Standard Height or Extended Height

HICKORY CHAIR® SILHOUETTES™

Side-By-Side Height Comparison (Measurements also apply to Dressmaker Silhouettes)

19³/₄" SEAT HEIGHT

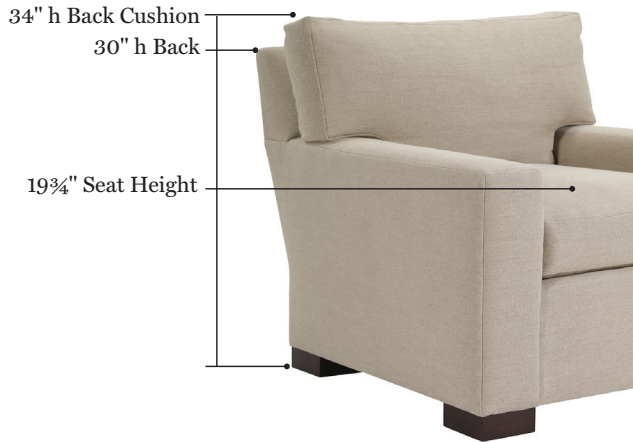

21³/₄" SEAT HEIGHT

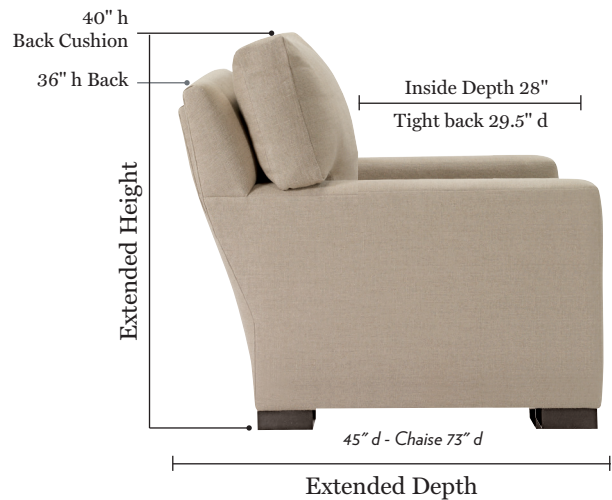
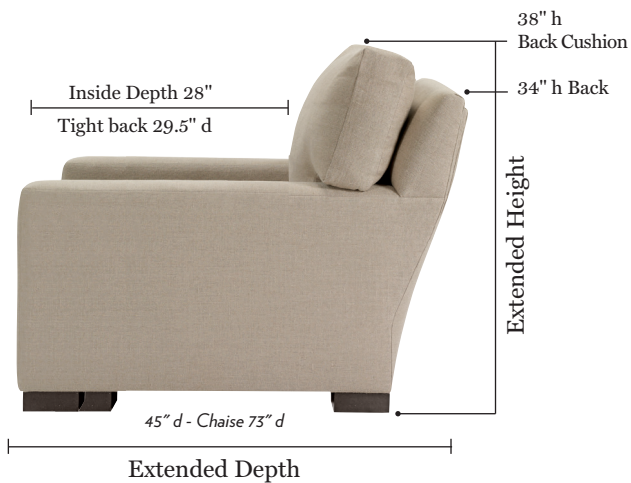
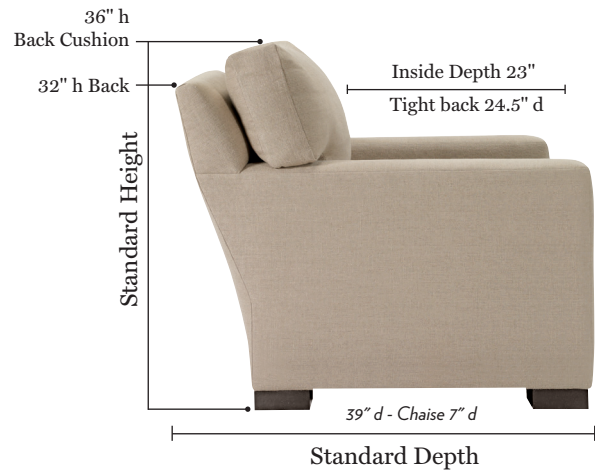
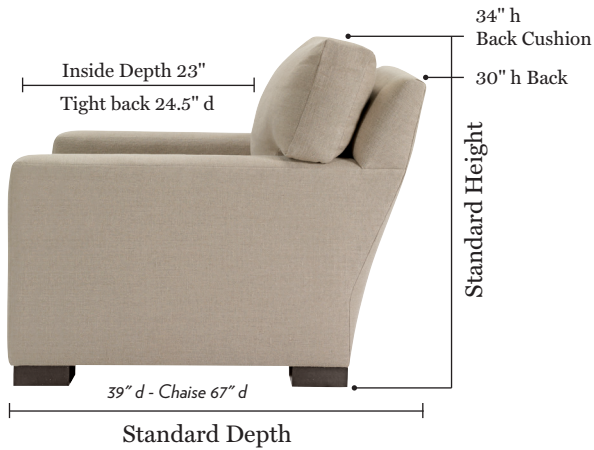

* The overall arm height will be 2" higher when selecting the 21³/₄" seat height option.
Custom size requests between standard and extended height and depth in 1" increments are available at no charge.
Other sizes may be requested as a special construction request through your customer service representative.

1

Choose Your Silhouette.

The arm style dictates the width on Non-M2M® styles. Refer to the price list for the exact width.

Overall Width Range:

W 26" - 40"



Chair

W 33" - 40"

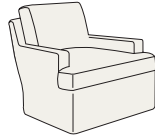

Swivel Chair*

W 33" - 40"

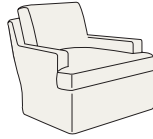

Swivel Glider*

W 39"

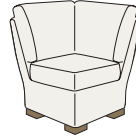

Square Corner

W 79"



Curved Wedge

W 77" - 90"

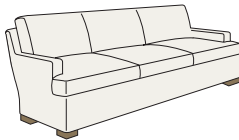

Sofa

W 77" - 90"

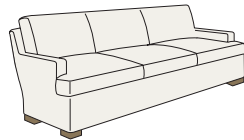

Sleeper Sofa*

W 80" - 84"

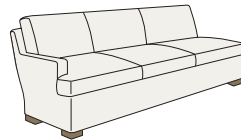

LAF Sleeper Sofa*

W 80" - 84"



RAF Sleeper Sofa*

*Only available in 21 3/4" Seat Height

M2M® (With made to measure, overall width matching arm choice will be produced)

W 28" - 120"

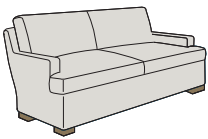

M2M® Sofa/Love Seat

W 28" - 120"

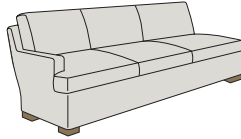

M2M® LAF Sofa

W 28" - 120"

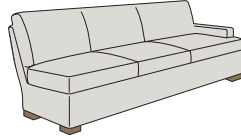

M2M® RAF Sofa

W 73" - 120"

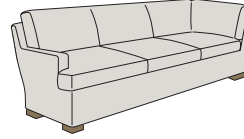

M2M® LAF Corner Sofa

W 73" - 120"

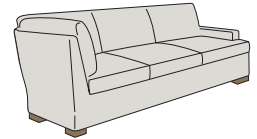

M2M® RAF Corner Sofa

W 28" to 40"

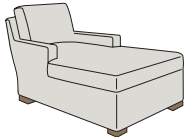

M2M® Chaise

W 28" - 46"

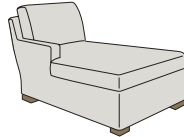

M2M® LAF Chaise

W 28" - 46"

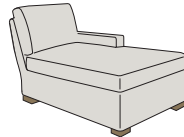

M2M® RAF Chaise

W 18" - 60"
D 18" - 60"



M2M® Ottoman

See worksheets on pages 70-72.

1

Choose Your Silhouette. (Cont.)

The arm style dictates the width on Non-M2M® styles. Refer to the price list for the exact width.

Curved Wedge

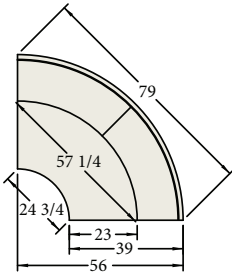

H Standard
D Standard

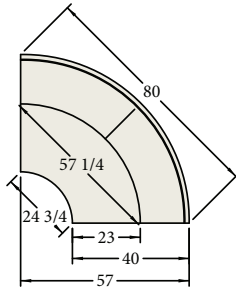

H Extended
D Standard

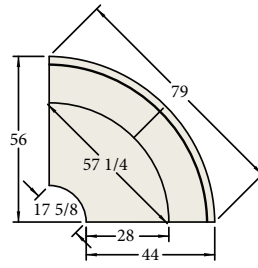

H Standard
D Extended

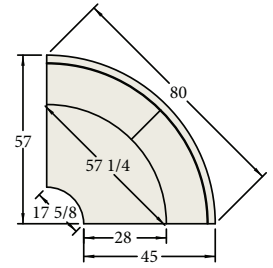

H Extended
D Extended

Square Corner

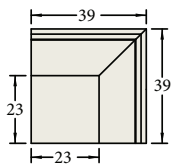

H Standard
D Standard

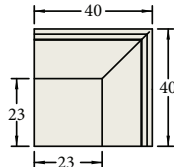

H Extended
D Standard

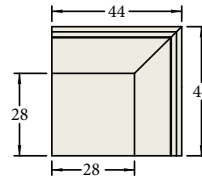

H Standard
D Extended

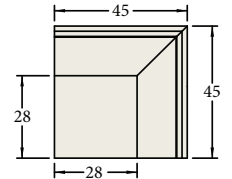

H Extended
D Extended

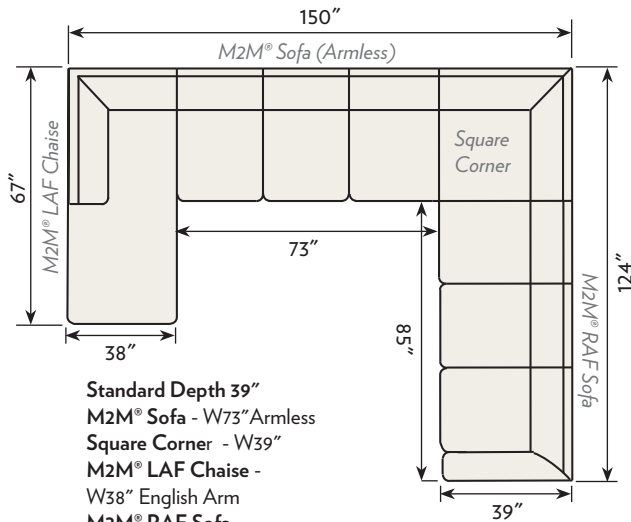

Standard Depth 39"
M2M® Sofa - W73" Armless
Square Corner - W39"
M2M® LAF Chaise -
W38" English Arm
M2M® RAF Sofa -
W85" English Arm

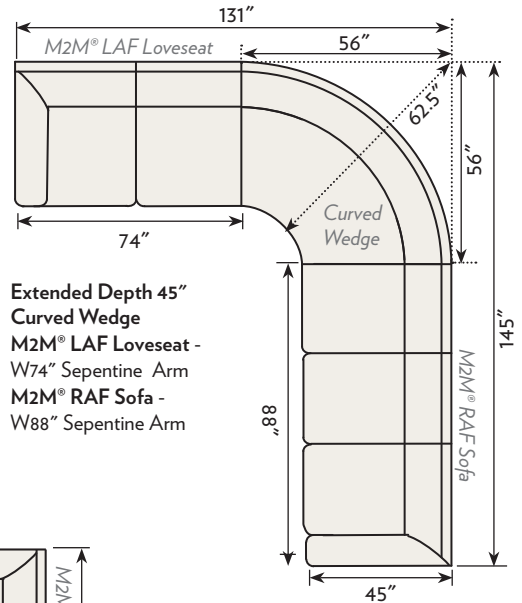

Extended Depth 45"
Curved Wedge
M2M® LAF Loveseat -
W74" Serpentine Arm
M2M® RAF Sofa -
W88" Serpentine Arm

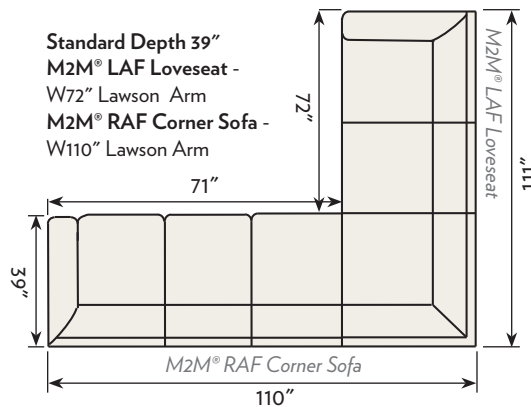

Standard Depth 39"
M2M® LAF Loveseat -
W72" Lawson Arm
M2M® RAF Corner Sofa -
W110" Lawson Arm

See worksheets on pages 70-72.

2 Choose Your Height and Depth.

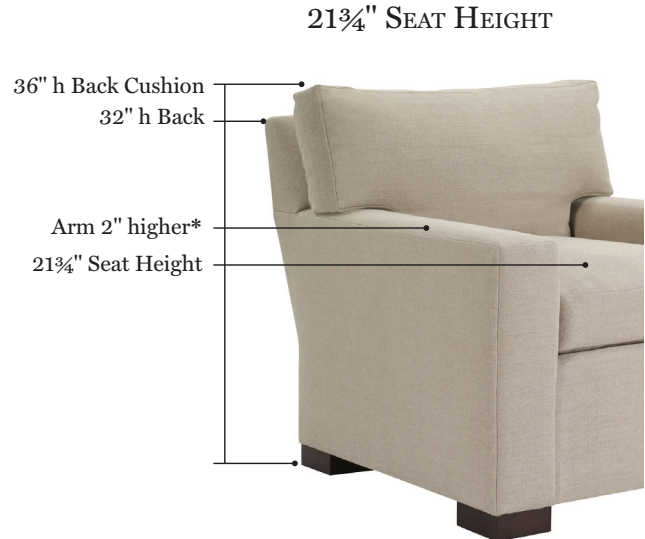

19.75" Seat Height Option:

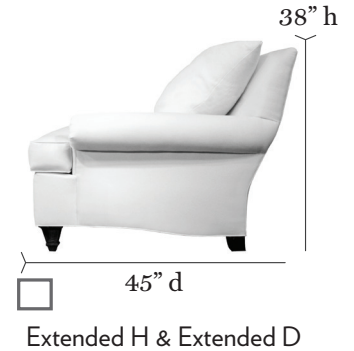
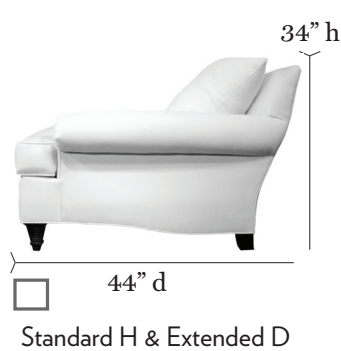
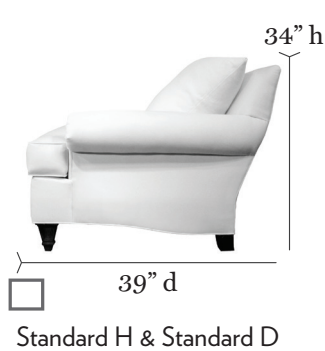

21.75" Seat Height Option:

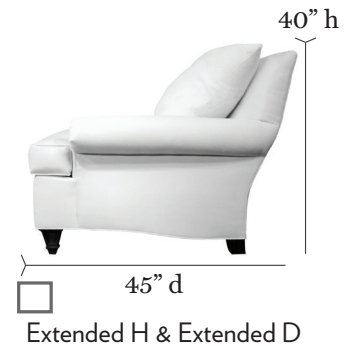
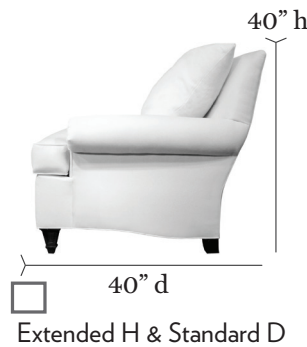
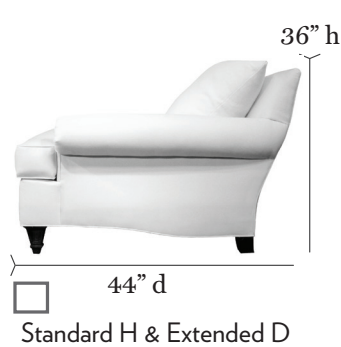
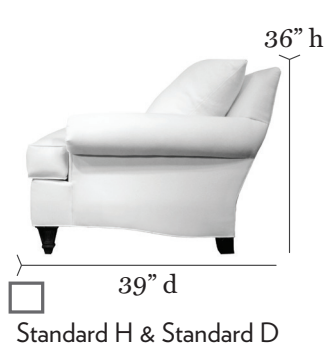

***The overall arm height will be 2" higher when selecting the 21 3/4" seat height option.**
 Custom size requests between standard and extended height and depth in 1" increments are available at no charge.
 Other sizes may be requested as a special construction request through your customer service representative.

See worksheets on pages 70-72.

3

Choose Your Arm.

A choice of Square or T Cushion is available on most styles. **Must Specify.**

Arm Width:

6" Arm

7.5" Arm

7.5" Arm



Armless
(SQ cushion only)



English
(Available in SQ or T cushion)



Lawson
(Available in SQ or T cushion)



Sock Lawson
(Available in SQ or T cushion)

7.5" Arm

7.5" Arm

7.5" Arm

7.75" Arm



Pleated Lawson
(Available in SQ or T cushion)



Lawson w/
Raised Panel
(SQ cushion only)



Sepentine
(SQ cushion only)



Slope w/ Panel
(SQ cushion only)

3.5" Arm

4.75" Arm

5.75" Arm



Narrow Square
(Available in SQ or T cushion)



Medium Square
(Available in SQ or T cushion)



Wide Square
(Available in SQ or T cushion)

See worksheets on pages 70-72.

4 Choose Your Back.



Box Edge Back



Knife Edge Back



Tight Back

5 Choose Your Base.

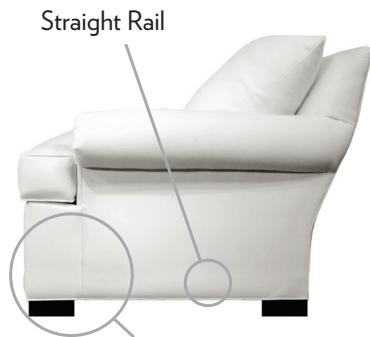

Exposed Leg (Front & Back)



Exposed Leg (Front & Back)



*Kick Pleat



Dressmaker

*Eight optional skirts available on standard Kick Pleat Skirts (up to 9") at No Additional Cost
See Skirt Options Section in the Hickory Chair Price List for additional information.

See worksheets on pages 70-72.

6 Choose Your Leg.

Front & Back

Straight Rail



Front Only

Serpentine Rail

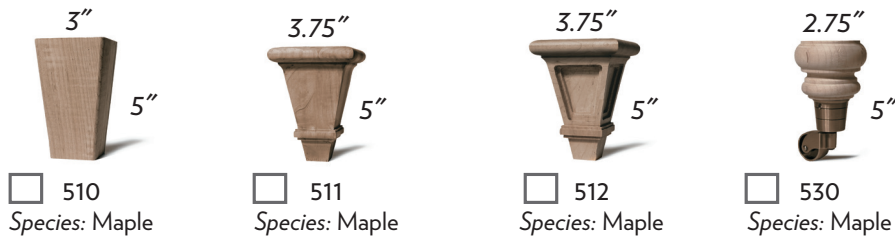

Standard Back Leg Post



Note: On all ottomans and leg styles where the front and back posts are all the same, the side rail is straight. Sleep sofas with 21 3/4" seat height are available with 2" or 3" tall leg styles only.

Note: On leg styles where the decorative leg is on the front only, the side rail has a serpentine shape. Does not apply to ottomans. Sleep sofas with 21 3/4" seat height are available with 2" or 3" tall leg styles only.

See worksheets on pages 70-72.

HICKORY CHAIR Silhouettes Upholstery

EXPOSED LEGS

DEALER NAME: _____

DEALER NO: _____

TAG FOR: _____

PO NO: _____

1 Pick Your Silhouette

*only available as armless

- | | |
|---|---|
| <input type="checkbox"/> Chair
(HC4100 - xx) | <input type="checkbox"/> M2M® Ottoman (18 3/4" h)
(HC4110 - 80) _____" w x _____" l (18" - 60") |
| <input type="checkbox"/> Sofa
(HC4120 - xx) | <input type="checkbox"/> M2M® Sofa
(HC4122 - xx) _____" w (28" - 120") |
| <input type="checkbox"/> M2M® LAF Sofa
(HC4130 - xx) _____" w (28" - 120") | <input type="checkbox"/> M2M® Chaise
(HC4128 - xx) _____" w (28" - 46") |
| <input type="checkbox"/> M2M® RAF Sofa
(HC4131 - xx) _____" w (28" - 120") | <input type="checkbox"/> M2M® LAF Corner Sofa
(HC4132 - xx) _____" w (73" - 120") |
| <input type="checkbox"/> M2M® LAF Chaise
(HC4138 - xx) _____" w (28" - 46") | <input type="checkbox"/> M2M® RAF Corner Sofa
(HC4133 - xx) _____" w (73" - 120") |
| <input type="checkbox"/> Curved Wedge *
(HC4148 - 00) | <input type="checkbox"/> LAF Sleep Sofa
(HC4142 - xx) |
| <input type="checkbox"/> Sleep Sofa
(HC4121 - xx) | <input type="checkbox"/> RAF Sleep Sofa
(HC4143 - xx) |
| <input type="checkbox"/> M2M® RAF Chaise
(HC4139 - xx) _____" w (28" - 46") | |
| <input type="checkbox"/> Square Corner *
(HC4149 - 00) | |

2 Pick Your Arm

- | | | |
|--|---|--|
| <input type="checkbox"/> Armless
SQ cushion (xxxx - 00) | <input type="checkbox"/> English
SQ cushion (xxxx - 01)
T cushion (xxxx - 21) | <input type="checkbox"/> Lawson
SQ cushion (xxxx - 04)
T cushion (xxxx - 24) |
| <input type="checkbox"/> Socket Lawson
SQ cushion (xxxx - 05)
T cushion (xxxx - 25) | <input type="checkbox"/> Pleated Lawson
SQ cushion (xxxx - 06)
T cushion (xxxx - 26) | <input type="checkbox"/> Lawson w/ Raised Panel
SQ cushion (xxxx - 07) |
| <input type="checkbox"/> Slope w/ Panel
SQ cushion (xxxx - 11) | <input type="checkbox"/> Narrow Square
SQ cushion (xxxx - 13)
T cushion (xxxx - 33) | <input type="checkbox"/> Serpentine
SQ cushion (xxxx - 10) |
| | <input type="checkbox"/> Medium Square
SQ cushion (xxxx - 14)
T cushion (xxxx - 34) | <input type="checkbox"/> Wide Square
SQ cushion (xxxx - 15)
T cushion (xxxx - 35) |

3 Pick Your Back

- Box Edge Back** **Knife Edge Back** **Tight Back**

4 Pick Your Leg & Finish. (Leg Species Maple)

- | | | | |
|---|---|---|---|
| <input type="checkbox"/> 201 2" front & back | <input type="checkbox"/> 310 3" front & back | <input type="checkbox"/> 412 4" front & back | <input type="checkbox"/> 511 5" front only |
| <input type="checkbox"/> 202 2" front & back | <input type="checkbox"/> 410 4" front & back | <input type="checkbox"/> 413 4" front & back | <input type="checkbox"/> 512 5" front only |
| <input type="checkbox"/> 203 2" front & back | <input type="checkbox"/> 411 4" front & back | <input type="checkbox"/> 510 5" front only | <input type="checkbox"/> 530 5" front only |

NOTE: Sleep Sofas only available with a 21 3/4" Seat Height. Only 2" or 3" high Legs available.

NOTE: 530 Leg standard with Antique Brass Ferrule with Caster. Optional Satin Nickel no charge upon request

5 Pick Your Seat Height, Overall Height & Overall Depth

- | | |
|---|---|
| <input type="checkbox"/> 19 3/4" Seat Height
Overall Height & Overall Depth Options | <input type="checkbox"/> 21 3/4" Seat Height
Overall Height & Overall Depth Options |
| <input type="checkbox"/> 34" Standard H & 39" Standard D | <input type="checkbox"/> 36" Standard H & 39" Standard D |
| <input type="checkbox"/> 34" Standard H & 44" Extended D | <input type="checkbox"/> 36" Standard H & 44" Extended D |
| <input type="checkbox"/> 38" Extended H & 40" Standard D | <input type="checkbox"/> 40" Extended H & 40" Standard D |
| <input type="checkbox"/> 38" Extended H & 44" Extended D | <input type="checkbox"/> 40" Extended H & 45" Extended D |

NOTE: The overall height and arm height will be 2" higher when selecting the 21 3/4" seat height. LAF and RAF chaises which are part of a sectional series require that you choose the depth respective of your other selections. 19 3/4" Seat Height and Extended Depth not available on Sleep Sofa.

6 Summarize your order Style Number _____ Fabric _____ Finish _____ Qty _____
(silhouette) HCxxxx - (arm) xx _____

7 Special Construction/Options (i.e. dual fabrics, nails, etc.)

HICKORY CHAIR Silhouettes Upholstery

DRESSMAKER

DEALER NAME: _____

DEALER NO: _____

TAG FOR: _____

PO NO: _____

1 Pick Your Silhouette

*only available as armless

- | | |
|---|--|
| <input type="checkbox"/> Chair
(HC4200 - xx) | <input type="checkbox"/> M2M® Ottoman (18 3/4" h)
(HC4210 - 80) _____" w x _____" l (18" - 60") |
| <input type="checkbox"/> Sofa
(HC4220 - xx) | <input type="checkbox"/> Sleep Sofa
(HC4221 - xx) |
| <input type="checkbox"/> M2M® LAF Sofa
(HC4230 - xx)
_____ " w (28" - 120") | <input type="checkbox"/> M2M® Sofa
(HC4222 - xx)
_____ " w (28" - 120") |
| <input type="checkbox"/> M2M® LAF Chaise
(HC4238 - xx)
_____ " w (28" - 46") | <input type="checkbox"/> M2M® RAF Sofa
(HC4231 - xx)
_____ " w (28" - 120") |
| <input type="checkbox"/> Curved Wedge *
(HC4248 - 00) | <input type="checkbox"/> M2M® LAF Corner Sofa
(HC4232 - xx)
_____ " w (73" - 120") |
| <input type="checkbox"/> Square Corner *
(HC4249 - 00) | <input type="checkbox"/> LAF Sleep Sofa
HC(4242 - xx) |
| | <input type="checkbox"/> RAF Sleep Sofa
(HC4243 - xx) |
| | <input type="checkbox"/> Chair w/Swivel & Glider *
(HC4202 - xx)
21 3/4" Seat Height Only |
| | <input type="checkbox"/> Chair w/Swivel *
(HC4201 - xx)
21 3/4" Seat Height Only |
| | <input type="checkbox"/> M2M® RAF Corner Sofa
(HC4233 - xx)
_____ " w (73" - 120") |
| | <input type="checkbox"/> M2M® Chaise
(HC4228 - xx)
_____ " w (28" - 46") |

2 Pick Your Arm

- | | | | |
|--|--|---|---|
| <input type="checkbox"/> Lawson
SQ cushion (xxxx - 05)
<input type="checkbox"/> T cushion (xxxx - 25) | <input type="checkbox"/> Armless
SQ cushion (xxxx - 00) | <input type="checkbox"/> English
SQ cushion (xxxx - 01)
<input type="checkbox"/> T cushion (xxxx - 21) | <input type="checkbox"/> Lawson
SQ cushion (xxxx - 04)
<input type="checkbox"/> T cushion (xxxx - 24) |
| <input type="checkbox"/> Slope w/ Panel
SQ cushion (xxxx - 11) | <input type="checkbox"/> Pleated Lawson
SQ cushion (xxxx - 06)
<input type="checkbox"/> T cushion (xxxx - 26) | <input type="checkbox"/> Lawson w/ Raised Panel
SQ cushion (xxxx - 07) | <input type="checkbox"/> Serpentine
SQ cushion (xxxx - 10) |
| | <input type="checkbox"/> Narrow Square
SQ cushion (xxxx - 13)
<input type="checkbox"/> T cushion (xxxx - 33) | <input type="checkbox"/> Medium Square
SQ cushion (xxxx - 14)
<input type="checkbox"/> T cushion (xxxx - 34) | <input type="checkbox"/> Wide Square
SQ cushion (xxxx - 15)
<input type="checkbox"/> T cushion (xxxx - 35) |

3 Pick Your Back

- Box Edge Back** **Knife Edge Back** **Tight Back**

5 Pick Your Seat Height

- | | |
|---|---|
| <input type="checkbox"/> 19 3/4" Seat Height
Overall Height & Overall Depth Options | <input type="checkbox"/> 21 3/4" Seat Height
Overall Height & Overall Depth Options |
| <input type="checkbox"/> 34" Standard H & 39" Standard D | <input type="checkbox"/> 36" Standard H & 39" Standard D |
| <input type="checkbox"/> 34" Standard H & 44" Extended D | <input type="checkbox"/> 36" Standard H & 44" Extended D |
| <input type="checkbox"/> 38" Extended H & 40" Standard D | <input type="checkbox"/> 40" Extended H & 40" Standard D |
| <input type="checkbox"/> 38" Extended H & 44" Extended D | <input type="checkbox"/> 40" Extended H & 45" Extended D |

NOTE: The overall height and arm height will be 2" higher when selecting the 21 3/4" seat height. LAF and RAF chaises which are part of a sectional series require that you choose the depth respective of your other selections. 19 3/4" Seat Height and Extended Depth not available on Sleep Sofa. 19 3/4 inch seat height not available on Chair w/Swivel, Chair w/Swivel & Glider.

5 Summarize Your Order

Style Number _____	Fabric _____	Finish _____	Qty _____
_____	_____	_____	_____
_____	_____	_____	_____
(silhouette) HCxxxx - (arm) xx	_____	_____	_____

6 Special Construction/Options (i.e. dual fabrics, nails, etc.)

HICKORY CHAIR Silhouettes Upholstery

KICK PLEAT

DEALER NAME: _____

DEALER NO: _____

TAG FOR: _____

PO NO: _____

1 Pick Your Silhouette

*only available as armless

- | | |
|---|--|
| <input type="checkbox"/> Chair
(HC4300 - xx) | <input type="checkbox"/> M2M® Ottoman (18 3/4" h)
(HC4310 - 80) _____" w x _____" l (18" - 60") |
| <input type="checkbox"/> Sofa
(HC4320 - xx) | <input type="checkbox"/> Sleep Sofa
(HC4321 - xx) |
| <input type="checkbox"/> M2M® LAF Sofa
(HC4330 - xx)
_____ " w (28" - 120") | <input type="checkbox"/> M2M® Sofa
(HC4322 - xx)
_____ " w (28" - 120") |
| <input type="checkbox"/> M2M® LAF Chaise
(HC4338 - xx)
_____ " w (28" - 46") | <input type="checkbox"/> M2M® RAF Sofa
(HC4331 - xx)
_____ " w (28" - 120") |
| <input type="checkbox"/> Curved Wedge *
(HC4348 - 00) | <input type="checkbox"/> M2M® LAF Corner Sofa
(HC4332 - xx)
_____ " w (73" - 120") |
| <input type="checkbox"/> Square Corner *
(HC4349 - 00) | <input type="checkbox"/> LAF Sleep Sofa
HC(4342 - xx) |
| | <input type="checkbox"/> RAF Sleep Sofa
(HC4343 - xx) |
| | <input type="checkbox"/> Chair w/Swivel & Glider *
(HC4302 - xx)
21 3/4" Seat Height Only |
| | <input type="checkbox"/> Chair w/Swivel *
(HC4301 - xx)
21 3/4" Seat Height Only |
| | <input type="checkbox"/> M2M® RAF Corner Sofa
(HC4333 - xx)
_____ " w (73" - 120") |
| | <input type="checkbox"/> M2M® Chaise
(HC4328 - xx)
_____ " w (28" - 46") |

2 Pick Your Arm

- | | | |
|--|---|--|
| <input type="checkbox"/> Armless
SQ cushion (xxxx - 00) | <input type="checkbox"/> English
SQ cushion (xxxx - 01)
T cushion (xxxx - 21) | <input type="checkbox"/> Lawson
SQ cushion (xxxx - 04)
T cushion (xxxx - 24) |
| <input type="checkbox"/> Socket Lawson
SQ cushion (xxxx - 05)
T cushion (xxxx - 25) | <input type="checkbox"/> Pleated Lawson
SQ cushion (xxxx - 06)
T cushion (xxxx - 26) | <input type="checkbox"/> Serpentine
SQ cushion (xxxx - 10) |
| <input type="checkbox"/> Slope w/ Panel
SQ cushion (xxxx - 11) | <input type="checkbox"/> Narrow Square
SQ cushion (xxxx - 13)
T cushion (xxxx - 33) | <input type="checkbox"/> Wide Square
SQ cushion (xxxx - 15)
T cushion (xxxx - 35) |
| | <input type="checkbox"/> Lawson w/ Raised Panel
SQ cushion (xxxx - 07) | <input type="checkbox"/> Medium Square
SQ cushion (xxxx - 14)
T cushion (xxxx - 34) |

3 Pick Your Back

- Box Edge Back** **Knife Edge Back** **Tight Back**

5 Pick Your Seat Height

- | | |
|---|---|
| <input type="checkbox"/> 19 3/4" Seat Height
Overall Height & Overall Depth Options | <input type="checkbox"/> 21 3/4" Seat Height
Overall Height & Overall Depth Options |
| <input type="checkbox"/> 34" Standard H & 39" Standard D | <input type="checkbox"/> 36" Standard H & 39" Standard D |
| <input type="checkbox"/> 34" Standard H & 44" Extended D | <input type="checkbox"/> 36" Standard H & 44" Extended D |
| <input type="checkbox"/> 38" Extended H & 40" Standard D | <input type="checkbox"/> 40" Extended H & 40" Standard D |
| <input type="checkbox"/> 38" Extended H & 44" Extended D | <input type="checkbox"/> 40" Extended H & 45" Extended D |

NOTE: The overall height and arm height will be 2" higher when selecting the 21 3/4" seat height. LAF and RAF chaises which are part of a sectional series require that you choose the depth respective of your other selections. 19 3/4" Seat Height and Extended Depth not available on Sleep Sofa. 19 3/4 inch seat height not available on Chair w/Swivel, Chair w/Swivel & Glider.

5 Summarize Your Order

Style Number _____	Fabric _____	Finish _____	Qty _____
_____	_____	_____	_____
_____	_____	_____	_____
(silhouette) HCxxxx - (arm) xx	_____	_____	_____

6 Special Construction/Options (i.e. dual fabrics, nails, etc.)

*Eight optional skirts available on standard Kick Pleat Skirts (up to 9") at No Additional Cost
See Skirt Options Section in the Hickory Chair Price List for additional information.